

Matchbox 2 plans

Homemade Puzzles

This is a very, very small puzzle box, measuring only 1-1/8" x 7/8" x 1-1/2" long, yet it takes **14** moves to open. Very easy to make-every piece is a simple rectangle. No curves, circles, inside cuts, holes or intricate pieces to cut. You could easily make this in a single day. Assembly is a little tricky, as the pieces are very small...



That's a 50p coin...

To make it at this size, you **must** use 1/16" plywood, and 1/8" wood for the sides, box ends and rails. You can make this bigger, by doubling all the dimensions.

The inner box

From 1/8" thick wood, cut these pieces:

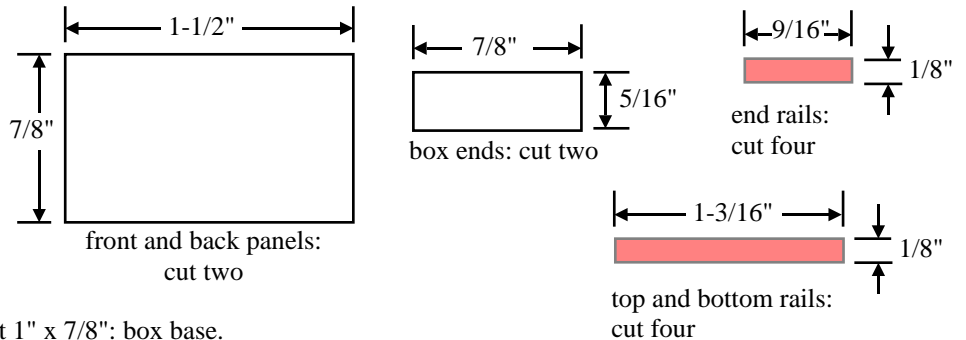

From 1/16" plywood, cut one piece at 1" x 7/8": box base.

Glue the box ends and base to the back panel, in the positions shown:

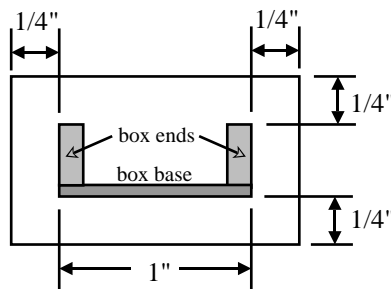

Glue the front panel onto the front edges of the box ends and base.

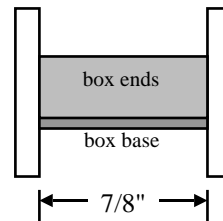

Glue the back panel rails in place. There should be a 1/16" gap between the rails and the back panel edges, another 1/16" gap between the rails and the box, and each rail is separated from the next by 1/16".

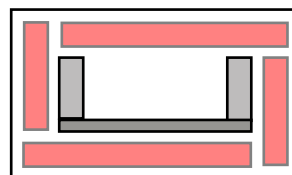

back panel rails

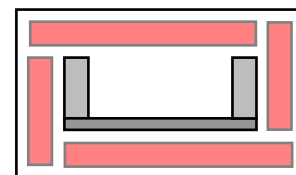

front panel rails

Glue the front panel rails on, with the same gaps. Note that the front panel is a mirror image of the back panel.

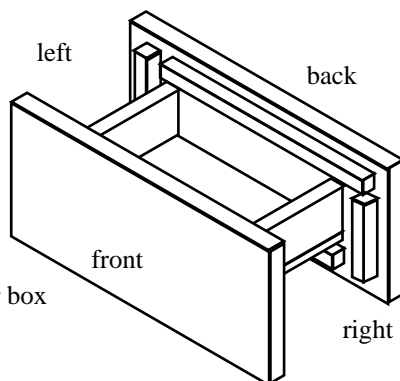

The completed inner box

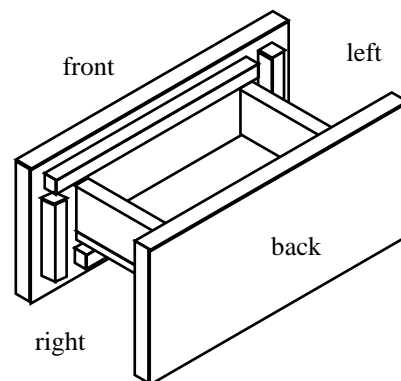

not to scale

The sliding panels

Each of the four sliding panels is made up of four layers: an inner, a runner 1, runner 2 and an outer layer. The two runner layers slide between the front and back rails. Make sure the rails are thin enough for two layers of 1/16" plywood to move along.

From 1/16" plywood, cut out these shapes;

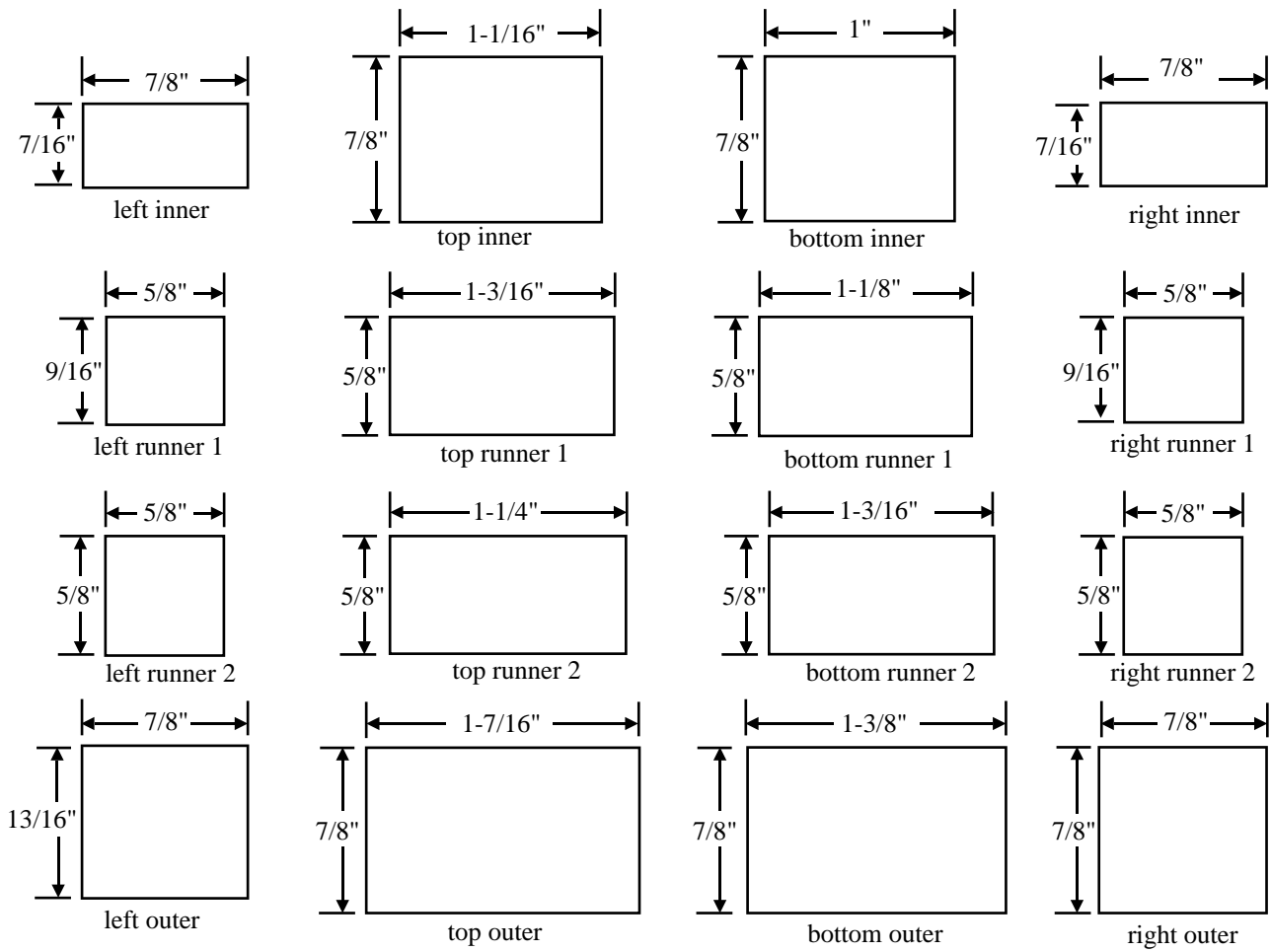

Assembling the sliding panels

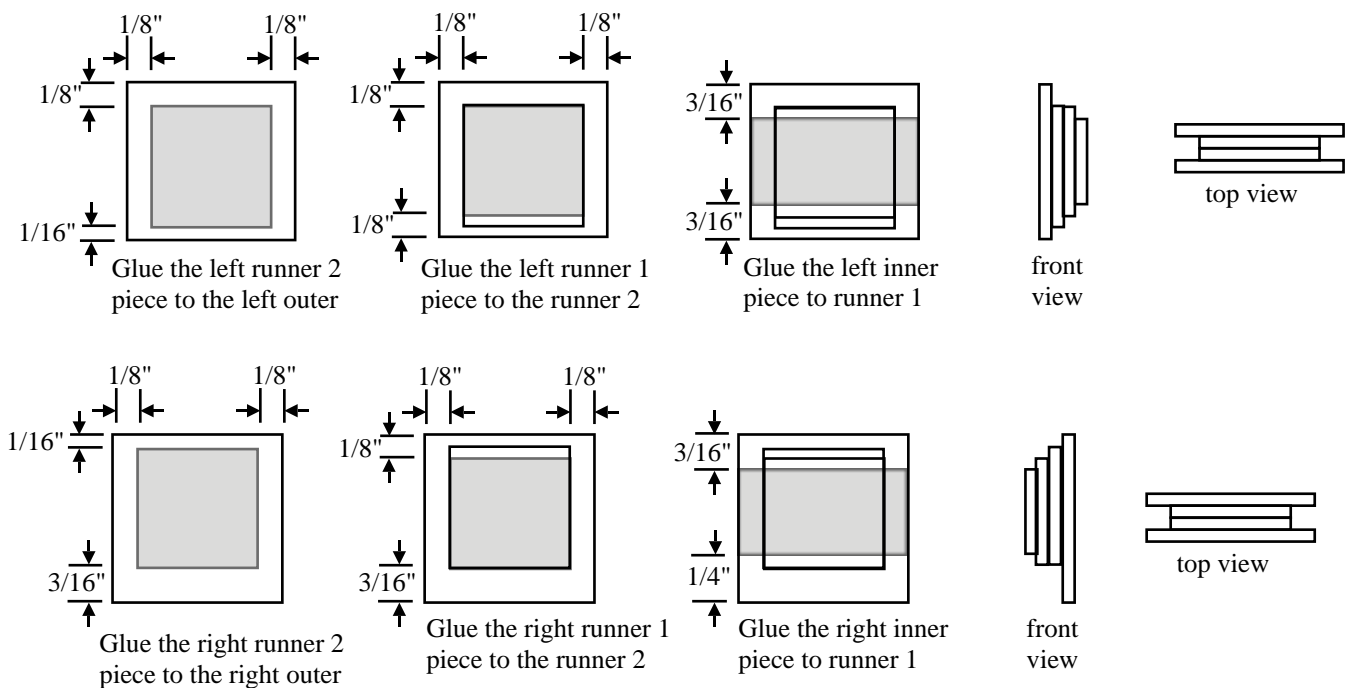

Assembling the sliding panels

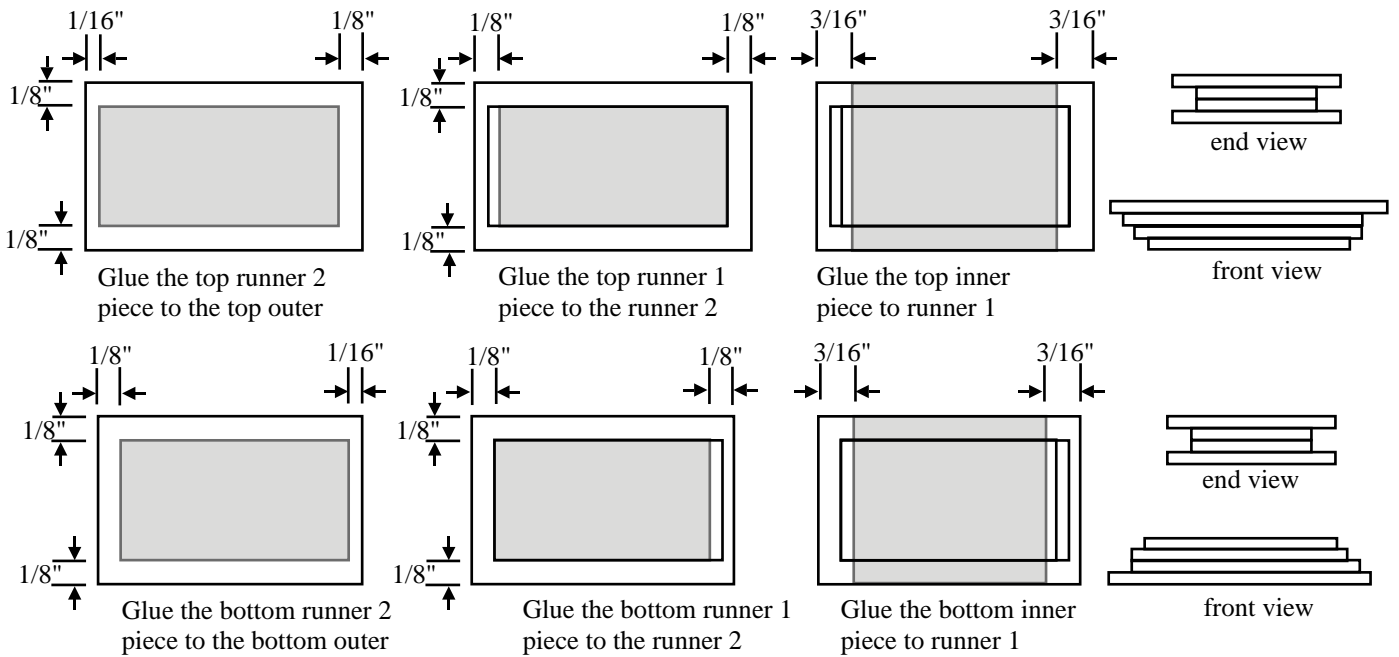

Assembling the box

Insert the bottom piece from the left, but leave enough space at the right end to insert the right panel up from the bottom. Leave enough space at the top of that panel to insert the top from the right. Again, leave enough space at the left end to insert the left panel from the top. Make sure the panels are the correct way round, as they will fit either way, but only work one way. When all the panels are in place, close the box, starting with the bottom panel, left, top and right, all one step at a time. The last panel to move will be the right panel.

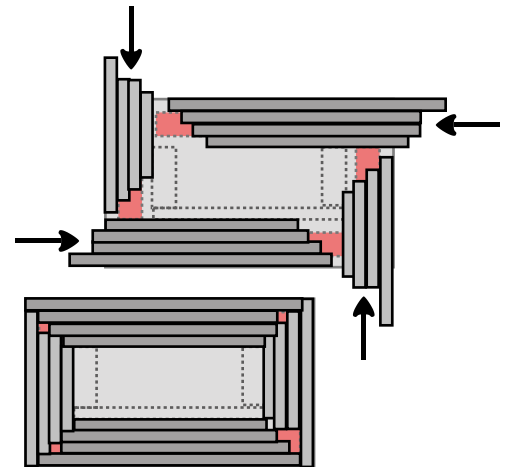

...and that's a 5p coin.

To finish off, I printed these patterns, sprayed them with Artist's Fixative to prevent the printer ink from running, and glued them onto the box. If you want to use these patterns, you'll need two of each.

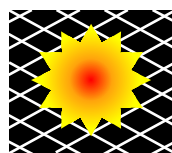

both ends

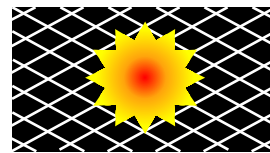

front and back

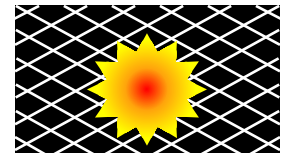

top and bottom

If you find any mistakes in these plans, please let me know, so that I can correct them.

Enjoy this puzzle!

These plans are free.
If you sell or give away this puzzle, please mention where the plans came from.
© Bruce Viney. January, 2009

Get more plans and solutions at **Homemade Puzzles**.
Web address: www.homemadepuzzles.co.uk
E-mail: bruce@homemadepuzzles.co.uk